

Article number: 12309000160100
Description: KLEE-coil 309 000 160.100
M16 Unhardened steel

Measures

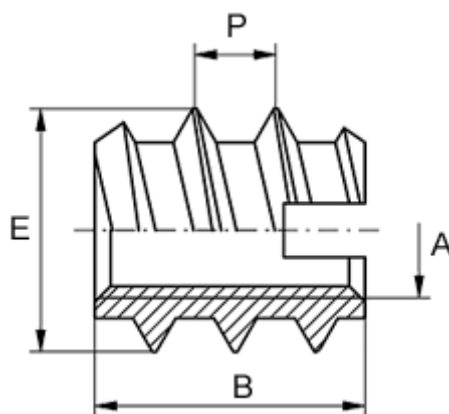

Female thread A	= M16
Length B	= 26
Male thread E	= 24.0
Min hole depth	= 30
Recommended bore diameter (plastic/hard wood)	= 20.6 to 20.8
Recommended bore diameter, soft wood (largest)	= 20.0
Thread pitch P	= 5.0